

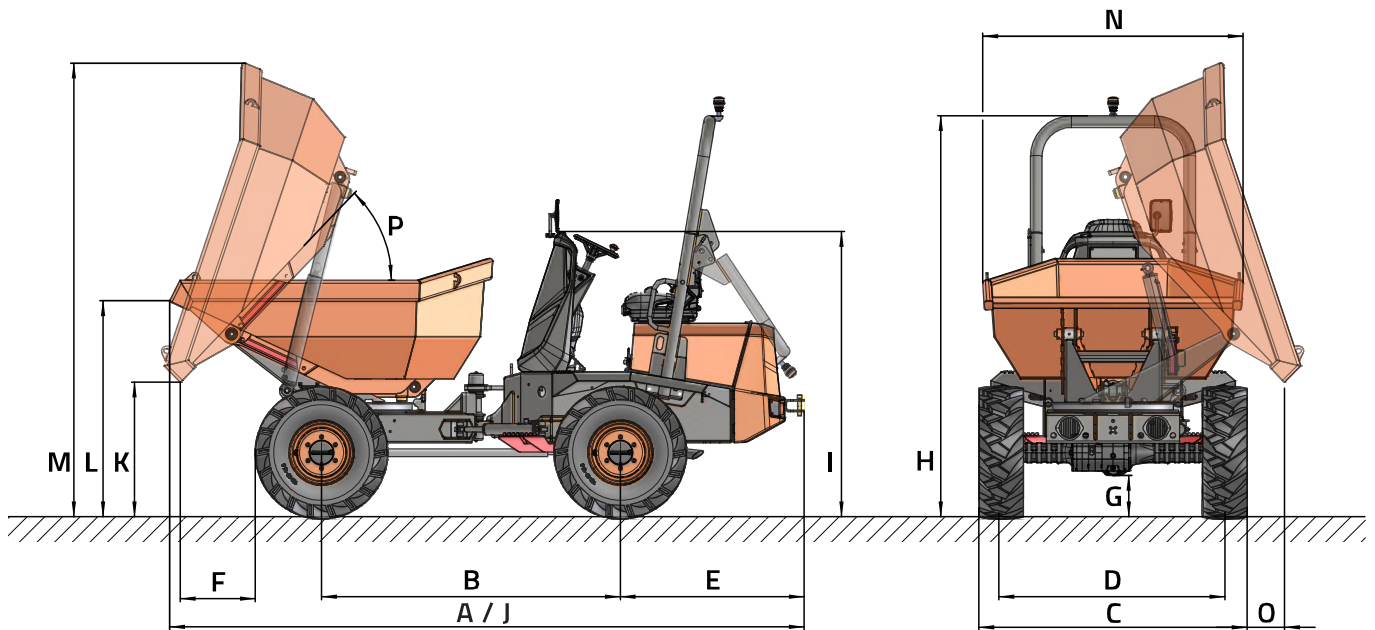

TECHNICAL DATA

GENERAL		D 201 AHG
Unloading system	-	Rotating
Load capacity	kg	2000
Chassis	-	Articulated and oscillating
Water hopper capacity	l	695
Level hopper capacity	l	1084
Heaped hopper capacity	l	1337
Empty weight	kg	2083
Transmission	-	Hydrostatic
ENGINE		
Brand	-	KUBOTA
Model	-	V1505-E4B
Power	kW	18,5
Operating speed	rpm	2300
Torque	N·m@rpm	92,6@1700
No. of cylinders	-	4
Emissions	-	Stage V - EPA Tier4
Injection	-	Mechanical pump
Exhaust aftertreatment	-	-
Noise	dB(A)	101
DRIVING		
Max. speed	km/h	20
Maximum gradient	%	50
External turning radius	mm	3710
Traction	-	4x4
Tyres	-	10.0/75-15,3"
HYDRAULIC SYSTEM		
Hydraulic circuit	-	12 cc gear pump
Flow rate	l/min	25
Working pressure	bar	200
TANK CAPACITY		
Fuel	l	37,5
Hydraulic system	l	37,4
BRAKES		
Service	-	Hydrostatic, retention
Parking	-	Negative, integrated in the transfer box

DIMENSIONS



DIMENSIONS (mm)	D 201 AHG
A	3995
B	1880
C	1500
D	1235
E	1200
F	480
G	240
H	2560
I	1805
J	3995
K	935
L	1305
M	2910
N	1480
O	260
DIMENSIONS (°)	
P	49



www.ausa.com

Products are subject to modifications without prior notice. Images throughout the spec sheet may refer to non-standard machines or non-available configurations depending on models.

AUSA's logo and corporate identity are property of the Company, they cannot be used without authorization.