

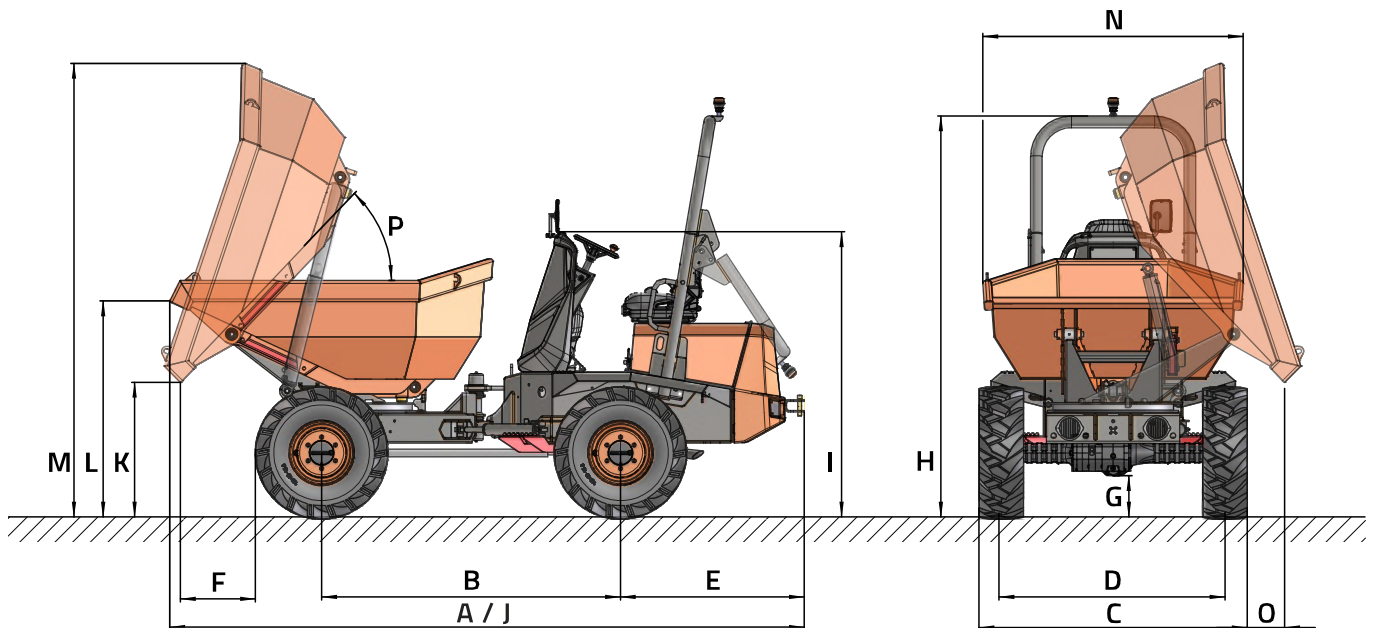

TECHNICAL DATA

GENERAL		D 301 AHG
Unloading system	-	Rotating
Load capacity	kg	3000
Chassis	-	Articulated and oscillating
Water hopper capacity	l	984
Level hopper capacity	l	1320
Heaped hopper capacity	l	1742
Empty weight	kg	2300
Transmission	-	Hydrostatic
ENGINE		
Brand	-	KUBOTA
Model	-	V1505-E4B
Power	kW	18,5
Operating speed	rpm	2300
Torque	N·m@rpm	92,6@1700
No. of cylinders	-	4
Emissions	-	Stage V - EPA Tier4
Injection	-	Mechanical pump
Exhaust aftertreatment	-	-
Noise	dB(A)	101
DRIVING		
Max. speed	km/h	18
Maximum gradient	%	50
External turning radius	mm	3955
Traction	-	4x4
Tyres	-	11,5/80-15.3
HYDRAULIC SYSTEM		
Hydraulic circuit	-	12 cc gear pump
Flow rate	l/min	25
Working pressure	bar	175
TANK CAPACITY		
Fuel	l	37,5
Hydraulic system	l	37,4
BRAKES		
Service	-	Sealed brakes. Hydraulic drive
Parking	-	Sealed brakes. Negative

DIMENSIONS



DIMENSIONS (mm)	D 301 AHG
A	4140
B	1950
C	1750
D	1460
E	1200
F	490
G	260
H	2605
I	1850
J	4140
K	865
L	1420
M	2950
N	1700
O	250
DIMENSIONS (°)	
P	46,5



www.ausa.com

Products are subject to modifications without prior notice. Images throughout the spec sheet may refer to non-standard machines or non-available configurations depending on models.

AUSA's logo and corporate identity are property of the Company, they cannot be used without authorization.